

**KADERS DORMANTS**

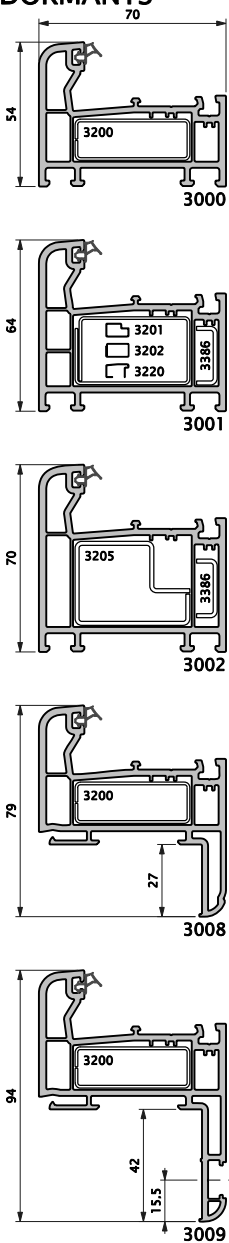

**STIJLEN TRAVERSES**

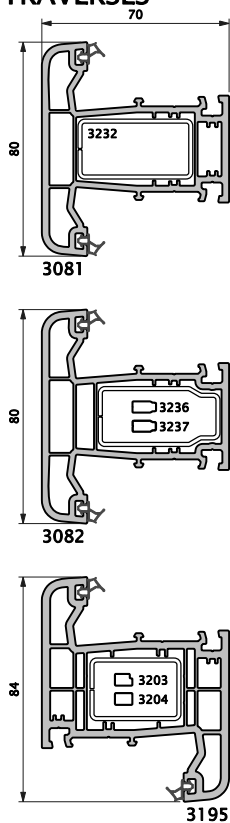

	50 mm	70 mm	90 mm
3081 3082 3091	3270	3273	3274
3000 3008 3009 3040 3041 3042 3051 3052 3062	3001 3002 3017 3018 3081 3082 3091	3048 3049 3068 3069	
3275 set kruisverbinding set raccord en croix			

3081	3271	3281	
3082	3271	3282	
3091	3271	3281	
3062	3370 3371		
3068	3272	3280	
3069	3272	3280	

**STIJLEN/VLEUGELS TRAVERSES/OUVRANTS**

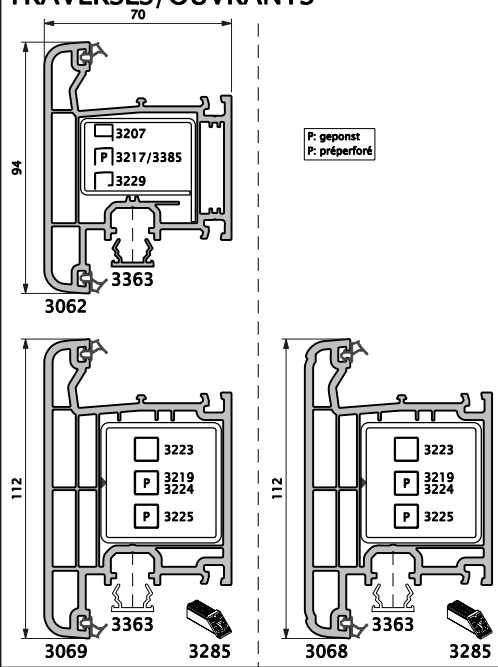

P: gepanst  
 P: préperforé

**VLEUGELS OUVRANTS**

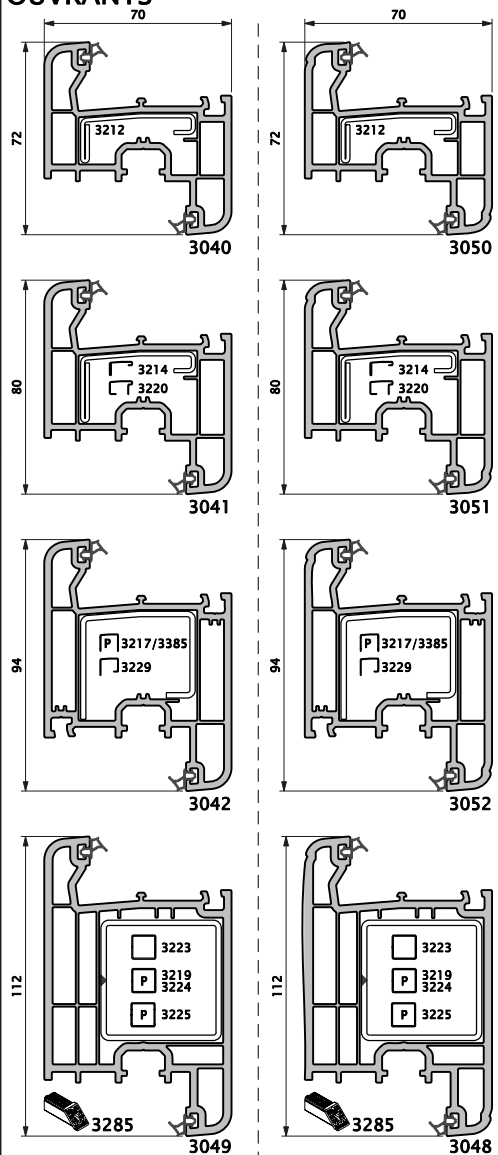

**MAKELAARS BATTEES**

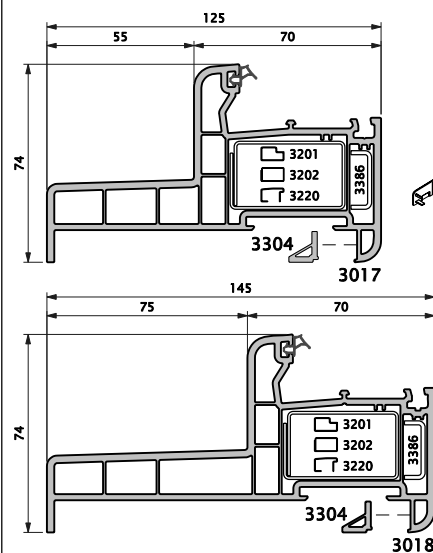
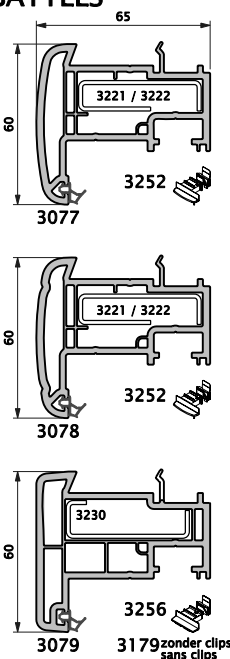

Allé gegevens zijn ter goede trouw en weerspiegelen onze huidige kennis. Zij kunnen derhalve niet tegen ons gebruikt worden. Technische wijzigingen voorbehouden.  
 Tous les renseignements donnés reflètent l'état actuel de nos connaissances et ne peuvent en aucun cas être retenus contre nous. Modifications techniques réservées.

B-04/07-84768-9002-8123



## FLEX

KADERS  
 DORMANTS  
 BLENDRAHMEN

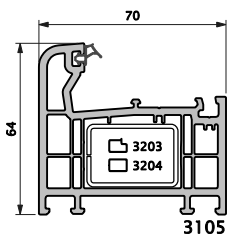

3105

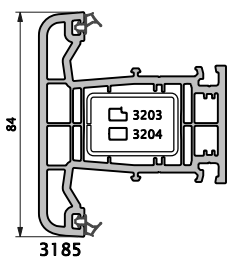

3185

STIJLEN  
 TRAVERSES  
 KÄMPFER

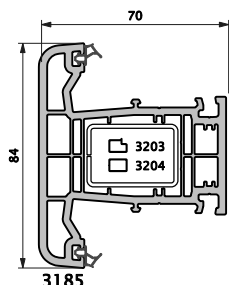

3185

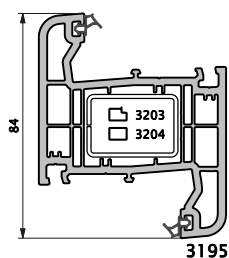

3195

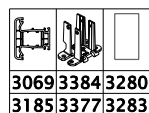

3069 3384 3280  
 3185 3377 3283

STIJLEN/VLEUGELS  
 TRAV/OUVR  
 KÄMPFER/FLÜGEL

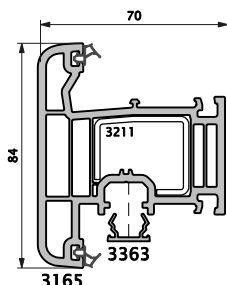

3165

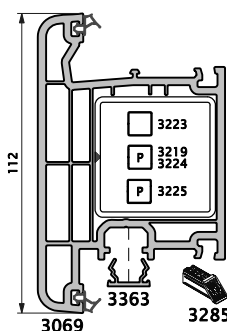

3069

P: geponst  
 P: préperforé

VLEUGELS  
 OUVRANTS  
 FLÜGEL

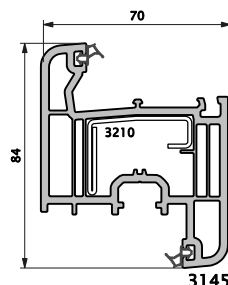

3145

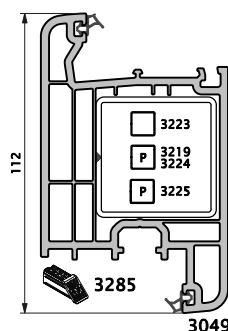

3049

MAKELAARS  
 BATTEES  
 STULPPROFIL

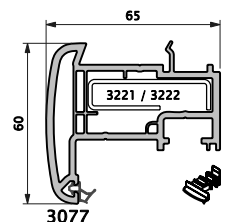

3077

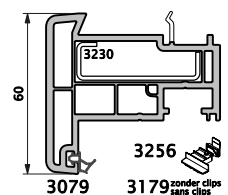

3079

3179 zonder clips  
 sans clips

## ROYAL

KADERS  
 DORMANTS  
 BLENDRAHMEN

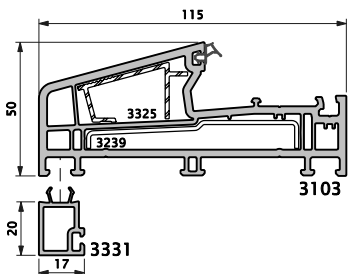

3103

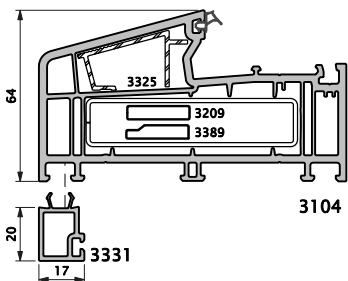

3104

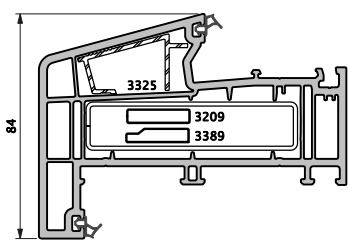

3114

STIJLEN  
 TRAVERSES  
 KÄMPFER

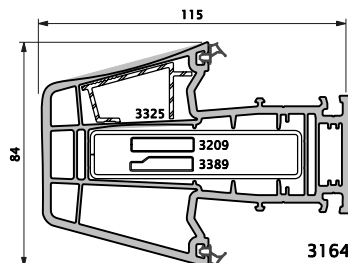

3164

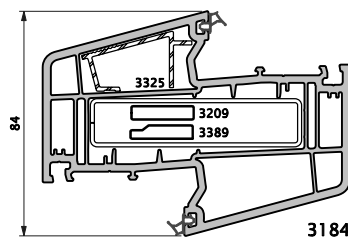

3184

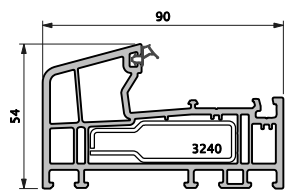

3111

VLEUGELS  
 OUVRANTS  
 FLÜGEL

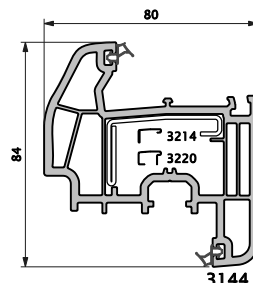

3144

OMKEERPROFIEL  
 RENVERSEUR  
 WECHSELPROFIEL

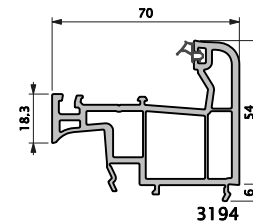

3194

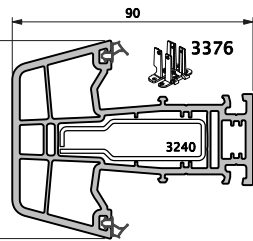

3112

MAKELAARS  
 BATTEES  
 STULPPROFIL

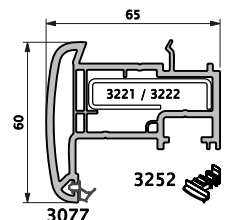

3077

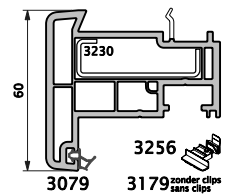

3079

3179 zonder clips  
 sans clips

TOEBEHOREN  
 ACCESSOIRES  
 ZUBEHÖR



2121



3299



3398



3399

Allé gegevens zijn ter goede trouw en weerspiegelend onze huidige kennis. Zij kunnen derhalve niet tegen ons gebruikt worden. Technische wijzigingen voorbehouden.  
 Tous les renseignements donnés reflètent l'état actuel de nos connaissances et ne peuvent en aucun cas être retenus contre nous. Modifications techniques réservées.

B-09/08-84770-9002-8123

# COMFORT

## KADERS DORMANTS

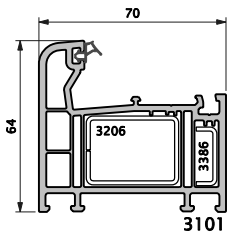

## STIJLEN TRAVERSES

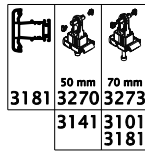
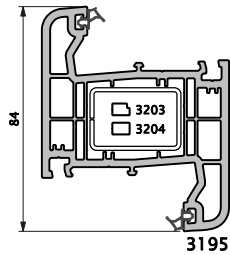
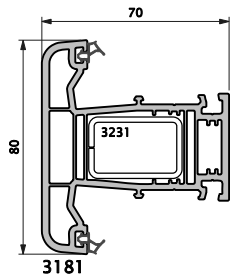

3275 set kruisverbinding  
set raccord en croix

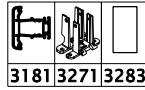

## VLEUGELS OUVRANTS

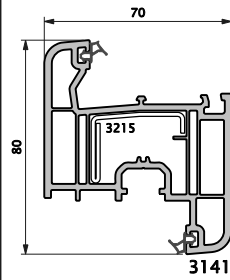

# LUX

## KADERS DORMANTS

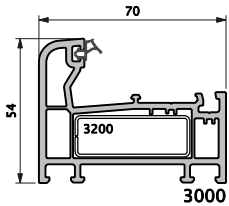

## STIJLEN TRAVERSES

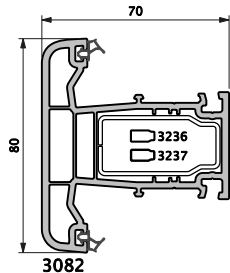

## VLEUGELS OUVRANTS

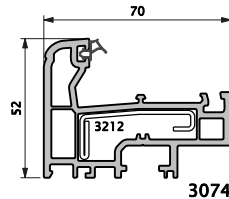
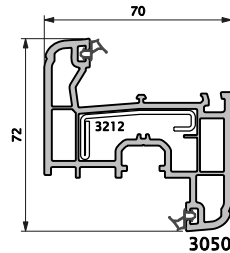
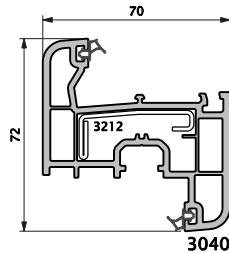

## TOEBEHOREN ACCESSOIRES

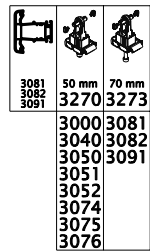
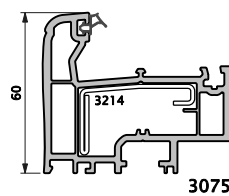
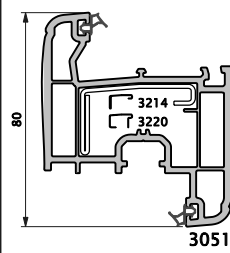
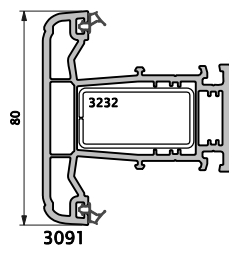
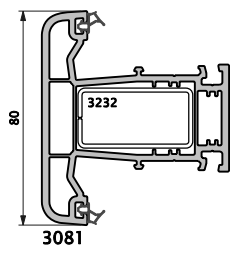
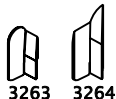
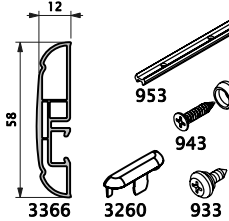
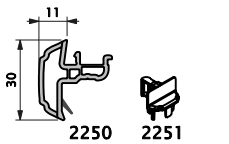

3275 set kruisverbinding  
set raccord en croix

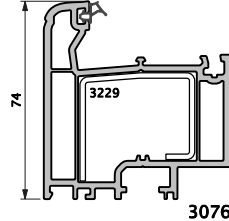
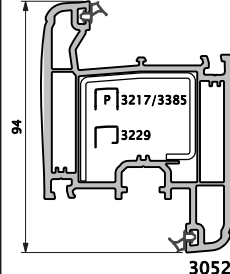
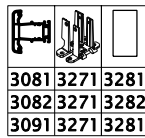

P: geponst  
P: préperforé

# AUTENTICA

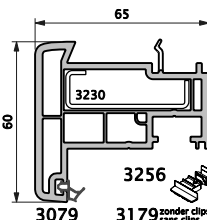
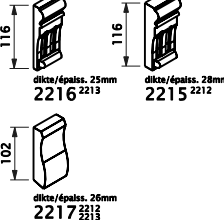
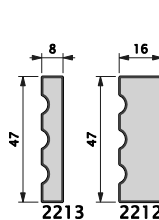
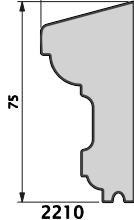
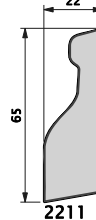
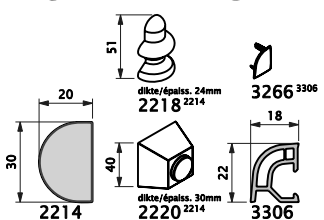

3256  
3179 zonder clips  
sans clips

Alle gegevens zijn ter goede trouw en weerspiegelen onze huidige kennis. Zij kunnen derhalve niet tegen ons gebruikt worden. Technische wijzigingen voorbehouden. Tous les renseignements donnés reflètent l'état actuel de nos connaissances et ne peuvent en aucun cas être retenus contre nous. Modifications techniques réservées.

B-09/08-84787-9002-8123



# DORPELS / KOPPELSYSTEMEN SEUILS / SYSTEMES DE JONCTION

S Y S T E M  
**zendow**<sup>®</sup>  
by deceuninck

Affiche 4

## DORPELS / SEUILS

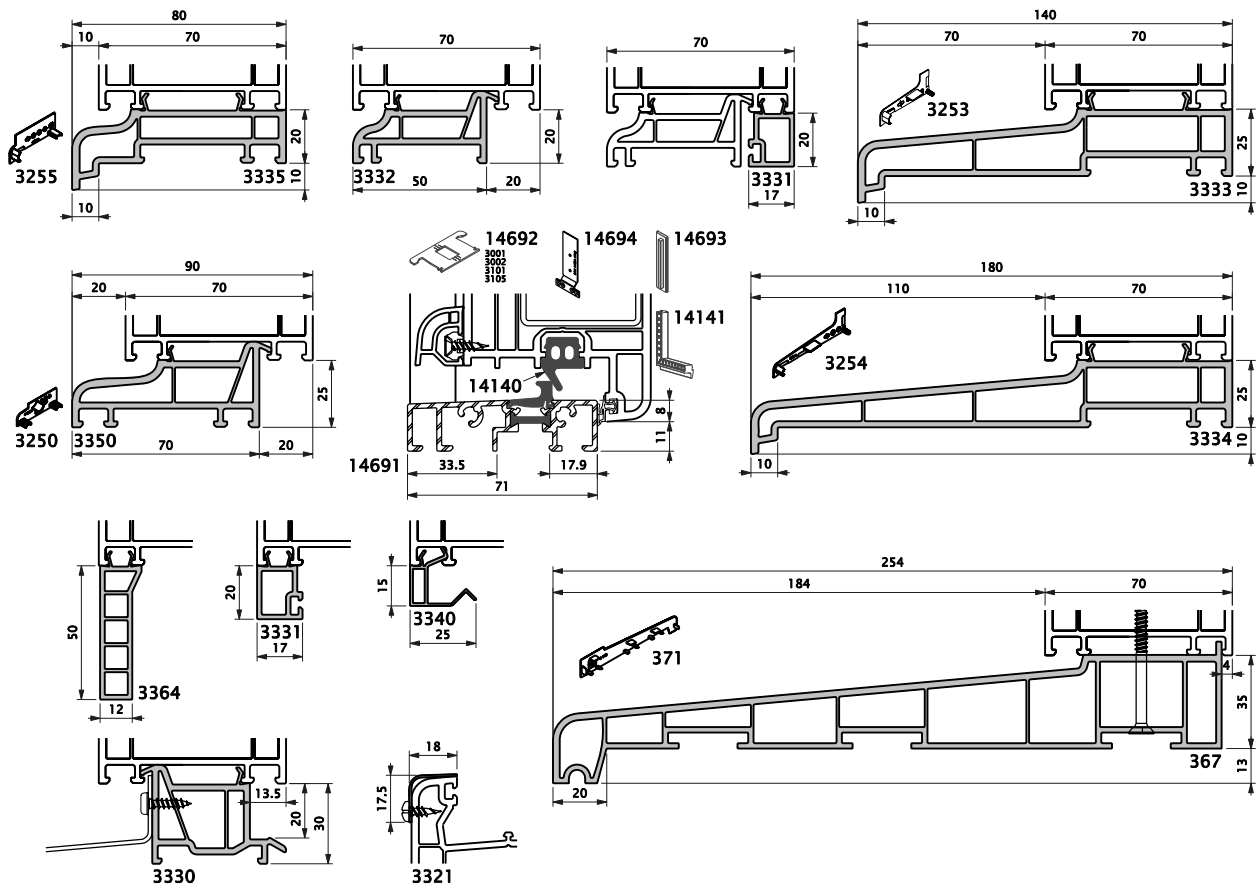

## KOPPELSYSTEMEN / SYSTEMES DE JONCTION

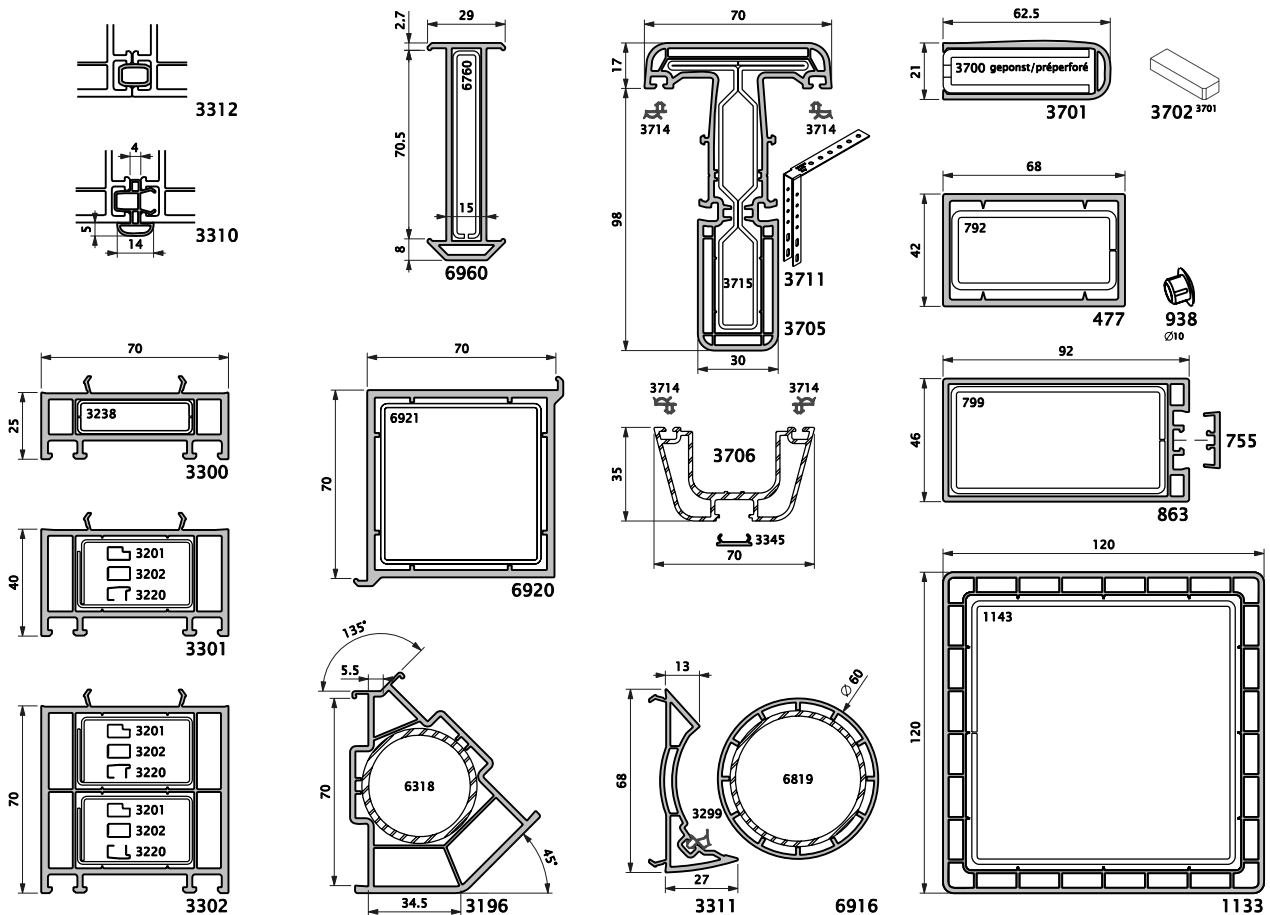

Alle gegevens zijn ter goede trouw en weerspiegelen onze huidige kennis. Zij kunnen derhalve niet tegen ons gebruikt worden. Technische wijzigingen voorbehouden. Tous les renseignements donnés reflètent l'état actuel de nos connaissances et ne peuvent en aucun cas être retenus contre nous. Modifications techniques réservées.



### GLASLATTEN / PARCLOSES

	BASIC	CONTEMPORARY	CUSTOM	
5 6				
7 8				
9 10				
11 12				
17 18				
19 20				
21 22				
23 24				
25 26				
27 28				
30 31				
32 33				
34 35				
36 37				
40 41				

### WATERLIJSTEN / JETS D'EAU

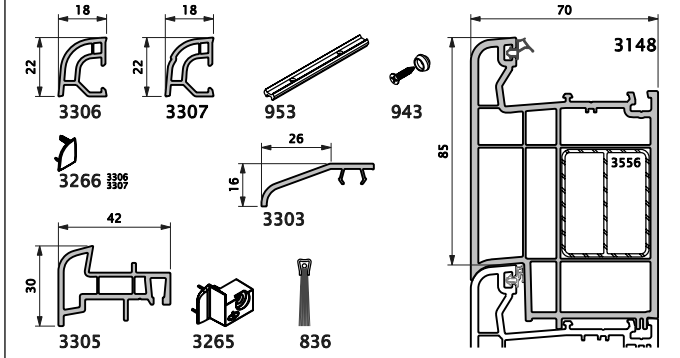

### KLEINHOUTEN / PETIT BOIS

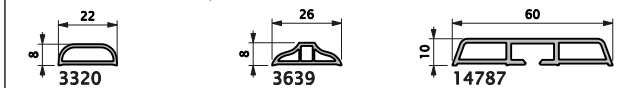

### DIVERSEN / DIVERS

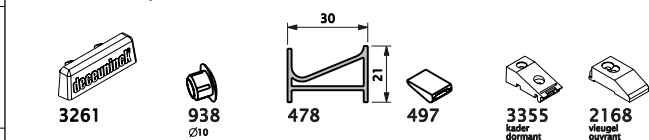

### DICHTINGEN / JOINTS



### VASTZETTINGSANKERS / PATTES DE SCHELEMENT

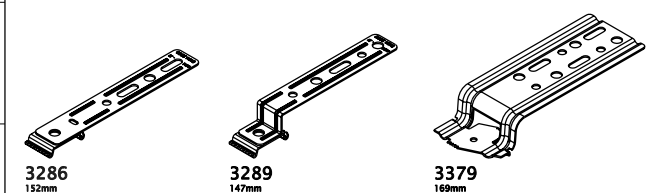

### AFWERKINGSPROFIELEN / PROFILES DE FINITION

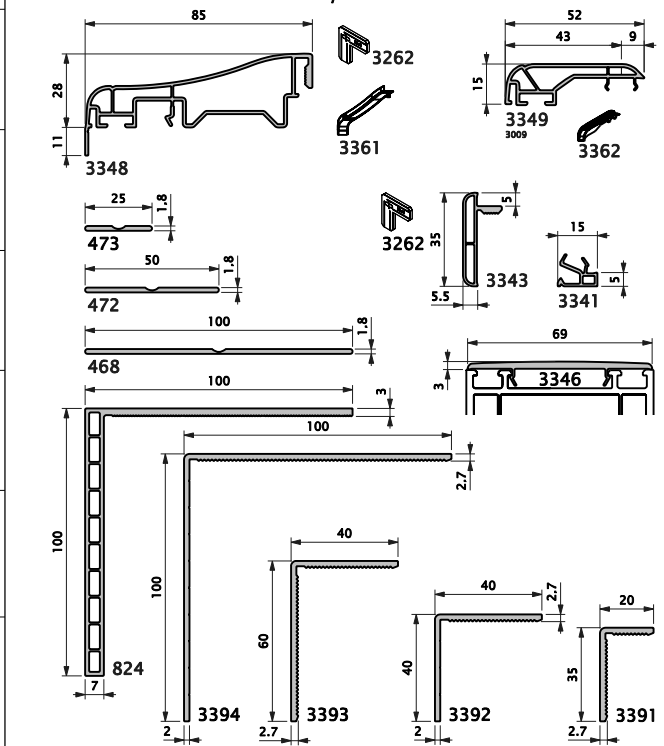

Alle gegevens zijn ter goede trouw en weerspiegelen onze huidige kennis. Zij kunnen derhalve niet tegen ons gebruikt worden. Technische wijzigingen voorbehouden. Tous les renseignements donnés reflètent l'état actuel de nos connaissances et ne peuvent en aucun cas être retenus contre nous. Modifications techniques réservées.



# MONORAIL

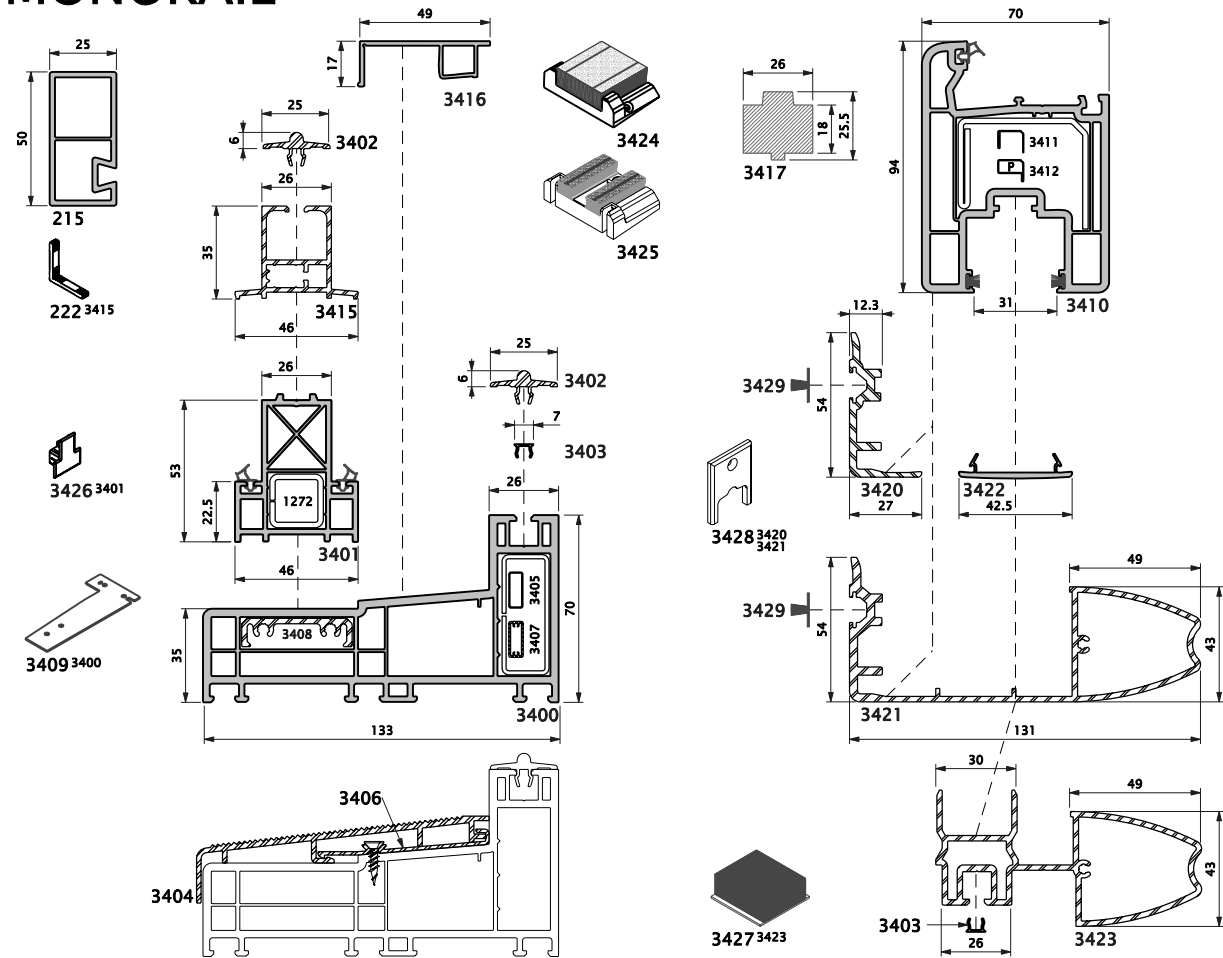

# VERANDA

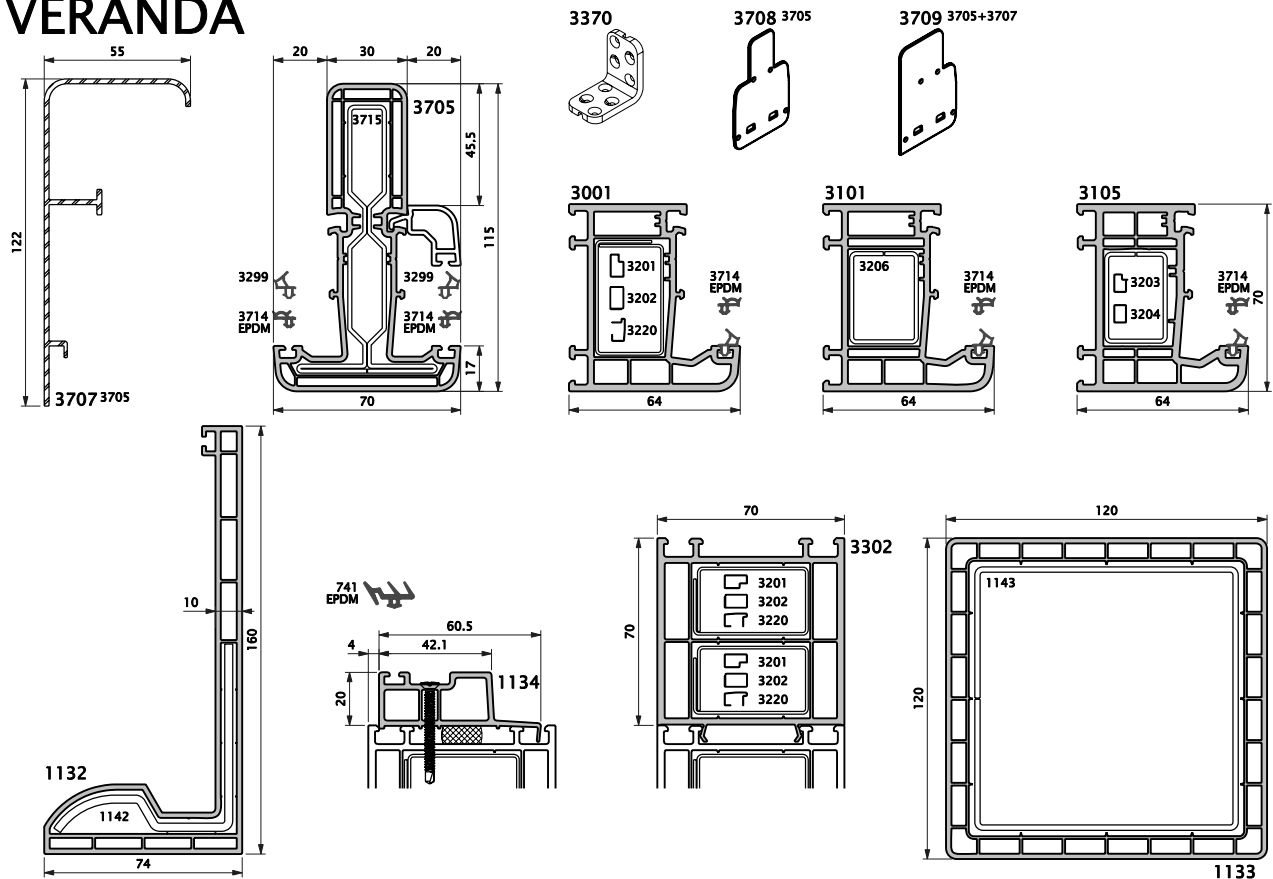

Alle gegevens zijn ter goede trouw en weerspiegelen onze huidige kennis. Zij kunnen derhalve niet tegen ons gebruikt worden. Technische wijzigingen voorbehouden. Tous les renseignements donnés reflètent l'état actuel de nos connaissances et ne peuvent en aucun cas être retenus contre nous. Modifications techniques réservées.

